

**Window Wall (Electronic)
Room Air Conditioner**

KWH22CRF, KWH22HRF

KWH27CRF, KWH27HRF

KWH39CRF, KWH39HRF

KWH52CRF, KWH52HRF

KWH60CRF, KWH60HRF

Refrigerant R32

CARE & USE

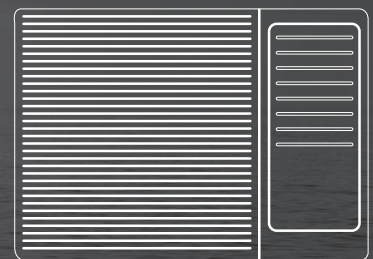

**Australians love
a Kelvinator**



Congratulations

Congratulations and thank you for choosing our Electric Window Wall room air conditioner. We are sure you will find your new air conditioner a pleasure to use. Before you use the air conditioner, we recommend that you read through the entire user manual, which provides the description of the air conditioner and its functions.

To avoid the risks that are always present when you use an electrical appliance, it is important that the air conditioner is installed correctly and that you read the safety instructions carefully to avoid misuse and hazards.

We recommend that you keep this instruction booklet for future reference and pass it on to any future owners.

After unpacking the air conditioner please check it is not damaged. If in doubt, do not use the air conditioner but contact your local Electrolux Customer Care Centre.

environmental tip

Information on disposal for users

- Most of the packing materials are recyclable. Please dispose of those materials through your local recycling depot or by placing them in appropriate collection containers.
- If you wish to discard this air conditioner, please contact your local authorities and ask for the correct method of disposal.
- This product contains refrigerant which must be reclaimed by a licensed refrigeration mechanic before the product can be disposed of.

refrigerant warning

This unit uses refrigerant R32 and must be disposed of by a licensed refrigeration mechanic with knowledge of appropriate gas reclamation methods.

caution

- The air conditioner is not intended for use by young children or infirmed persons without supervision.
- Young children should be supervised to ensure that they do not play with the air conditioner.
- Contact an authorised installer for installation of this unit.
- Contact an authorised service technician for repair or maintenance of this unit.
- If the power cord is to be replaced, replacement work must be performed by authorised personnel only.
- Installation work must be performed in accordance with the national wiring Standards by authorised personnel only.

Contents

Safety precautions	3
Prior to operation.....	4
Unit parts identification	5
Operating instructions.....	5
Maintenance.....	9
Installation instructions	10
Troubleshooting	12

Conditions of use

This appliance is designed and intended to be used in normal domestic applications only.

Important information that may impact your Manufacturer's Warranty

Adherence to the directions for use in this manual is extremely important for health and safety. Failure to strictly adhere to the requirements in this manual may result in personal injury, property damage and affect your ability to make a claim under the Kelvinator manufacturer's warranty provided with your product. Products must be used, installed and operated in accordance with this manual. You may not be able to claim on the Kelvinator manufacturer's warranty in the event that your product fault is due to failure to adhere this manual.

Safety precautions

caution

- Contact an authorised service technician for repair or maintenance of this unit.
- Contact a licensed installer for installation of this unit.
- The air conditioner is not intended for use by young children or infirmed persons without supervision.
- Young children should be supervised to ensure that they do not play with the air conditioner.
- This air conditioner must be installed in accordance with AS/NZS 3000:2000 and your electricity suppliers rules.
- There are local council rules regarding maximum allowable noise levels emitted by air conditioners.
- If the power cord is to be replaced, replacement work shall be performed by authorised personnel only.
- Installation work must be performed in accordance with the national wiring standards by authorised personnel only. Wrong connection can cause overheating or fire.

Inside this manual you will find many helpful hints on how to use and maintain your air conditioner properly.

Just a little preventative care on your part can save you a great deal of time and money over the life of your air conditioner. You'll find many answers to common problems in the chart of troubleshooting tips. If you review the chart of Troubleshooting Tips first, you may not need to call for service.

Meanings of symbols used in this manual are shown below:

warning

This symbol indicates information concerning your personal safety

caution

This symbol indicates information on how to avoid damaging the appliance

tips and information

This symbol indicates tips and information about use of the appliance

environmental tip

This symbol indicates tips and information about economical and ecological use of the appliance























This symbol indicates never to do this



















This symbol indicates always do this

warning

	Do not use means to accelerate the defrosting process or to clean, other than those recommended by the manufacturer.
	Do not store the appliance in a room with continuously operating ignition sources (for example open flames, an operating electric heater or an operating gas appliance with a continuously lit pilot flame).
	Do not pierce or burn.
	Be aware that the refrigerant may be odourless.
	Connect with power properly. Otherwise, it may cause electric shock or fire due to excess heat generation.
	Do not operate or stop the unit by switching on or off the power. It may cause electric shock or fire due to heat generation.
	Do not damage or use an unspecified power cord. It may cause electric shock or fire. If the power cord is damaged, it must be replaced by the manufacturer or an authorised service centre or a similarly qualified person in order to avoid a hazard.
	Do not modify power cord length or share the outlet with other appliances. It may cause electric shock or fire due to heat generation.
	Do not operate with wet hands or in damp environment. It may cause electric shock.
	Do not direct airflow at room occupants only. This could damage your health.
	Always ensure effective earthing. No earthing may cause electric shock.
	Do not allow water to run into electric parts. It may cause failure of machine or electric shock.
	Always install circuit breaker and a dedicated power circuit. No installation may cause fire and electric shock.
	Disconnect the power if strange sounds, smell, or smoke comes from the unit. It may cause fire and electric shock.
	Do not use the socket if it is loose or damaged. It may cause fire and electric shock.
	Do not open the unit during operation. It may cause electric shock.
	Keep firearms away. It may cause a fire.
	Do not use the power cord close to heating appliances. It may cause fire and electric shock.
	Do not use the power cord near flammable gas or combustibles, such as gasoline, benzene, thinner, etc. It may cause an explosion or fire.
	Ventilate room before operating air conditioner if there is a gas leakage from another appliance. It may cause explosion, fire and burns.
	Do not disassemble or modify unit. It may cause failure and electric shock.

Safety precautions

caution

	When the air filter is to be removed, do not touch the metal parts of the unit. It may cause an injury.
	Do not clean the air conditioner with water. Water may enter the unit and degrade the insulation. It may cause an electric shock.
	Ventilate the room well when used together with a stove, etc. An oxygen shortage may occur.
	Do not put a pet or house plant where it will be exposed to direct air flow. This could injure the pet or plant.
	Do not use for special purposes. Do not use this air conditioner to preserve precision devices, food, pets, plants, and art objects. It may cause deterioration of quality, etc.
	Stop operation and close the window in storm or hurricane. Operation with windows opened may cause wetting of indoor and soaking of household furniture.
	Hold the plug by the head of the power plug when taking it out. It may cause electric shock and damage.
	Turn off the main power switch when not using the unit for a long time. It may cause failure of product or fire.
	Do not place obstacles around air-inlets or inside of air-outlet. It may cause failure of appliance or accident.
	Ensure that the installation bracket of the appliance is not damaged due to prolonged exposure. If bracket is damaged, there is concern of damage due to falling of unit.
	Always insert the filters securely. Clean filter once every two weeks. Operation without filters may cause failure.
	Do not use strong detergent such as wax or thinner but use a soft cloth. Appearance may be deteriorated due to change of product colour or scratching of its surface.
	Do not place heavy object on the power cord and ensure that the cord is not compressed. There is danger of fire or electric shock.
	If water enters the unit, turn the unit off and disconnect the power, contact a qualified service technician.
	Use caution when unpacking and installing. Sharp edges could cause injury.
	Do not drink water drained from air conditioner. It contains contaminants and could make you sick.

Prior to Operation

Preparing for operation

- 1 Contact an authorised installation specialist for installation.
- 2 Plug in the power plug properly.
- 3 Do not use a damaged or non-standard power cord.
- 4 Do not share the same outlet with other appliances.
- 5 Do not use an extension cord.
- 6 Do not start/stop operation by plugging/unplugging the power cord.

Usage

- 1 Exposure to direct airflow to occupants, pets or plants for an extended period of time could be hazardous to their health.
- 2 Due to the possibility of oxygen deficiency, ventilate the room when used together with stoves or other heating devices.

Cleaning and maintenance

- 1 Do not touch the metal parts of the unit when removing the filter. Injuries can occur when handling sharp metal edges.
- 2 Do not use water to clean inside the air conditioner. Exposure to water can destroy the insulation, leading to possible electric shock.
- 3 When cleaning the unit, first make sure that the power and circuit breaker are turned off.

Operating temperature

Cooling Mode

Indoor		Outdoor	
Max.	Min.	Max.	Min.
32°C	17°C	43°C	17°C

Heating Mode

Indoor		Outdoor	
Max.	Min.	Max.	Min.
27°C	10°C	24°C	-7°C

Note: Performance may be reduced outside of these operating temperatures.

Unit parts identification

- 1 Front panel
- 2 Air filter
- 3 Frame
- 4 Cabinet
- 5 Air inlet grille (outdoor side)
- 6 Air outlet grille
- 7 Electronic control keypad
- 8 Power supply cord and plug
- 9 Remote control

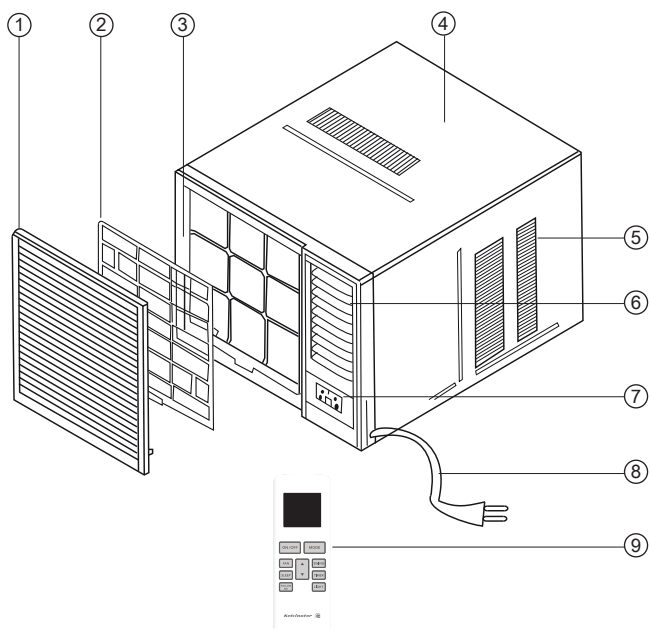

- 1 Power cord conductors are distinguished according to colour as follows (see Fig.1)
- 2 For your safety and protection, this unit is earthed through the power cord (see Fig.2)
Please contact the manufacturer or its service agent or a similar qualified person if you want to replace it.
- 3 Be sure that the unit is being correctly grounded. The wall outlet (Air-Break Switch) should be provided with reliable earth wire.
- 4 The unit should be provided with an individual circuit and the circuit breaker/fuse rating should be the same as that of the power cord and wall outlet.

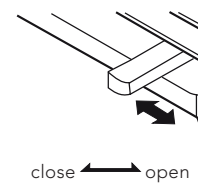
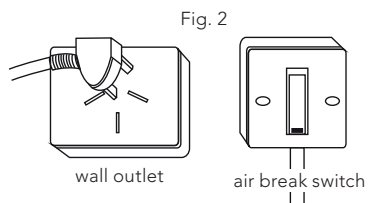
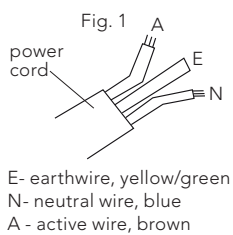

Operating instructions

Controls

The electronic control keypad will look like one of the following:

Reverse Cycle Models

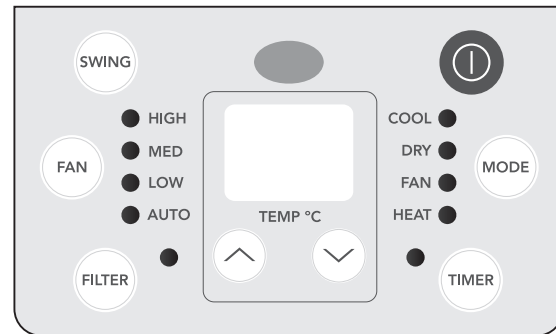

Cooling only models

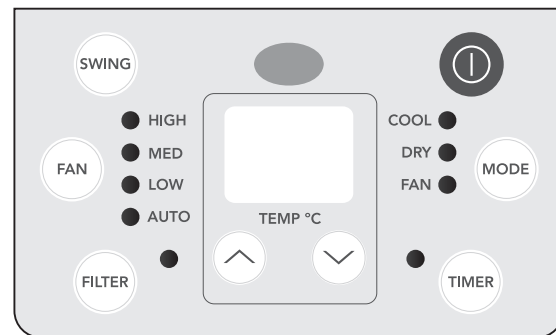

Vent control

The vent control is located above the control keypad. The operation method is different on different models (see the following figures).

For maximum cooling efficiency, CLOSE the vent. This will allow internal air circulation.

To open the vent, slide the lever to the left. To close it, slide to the right.

To open the vent, set the lever to the right position. To close it, set the lever in the left position.

Operating instructions

Operating instructions

Power:

Press the POWER keypad to turn the unit on/off.
(The TIMER keypad controls the auto start/stop feature of the unit.)

Mode:

Press the "MODE" keypad to select the appropriate operating mode. For the Reverse Cycle models (cooling & heating), the mode selection will alternate between AUTO, HEATING, COOLING, FAN and DRY. For the Cooling only models, select the operating mode from AUTO, COOLING, FAN and DRY. The green indicator light beside the "MODE" option will illuminate, identifying the mode selected.

When using the DRY and AUTO mode, you cannot select a fan speed. The fan motor operates on LOW speed in DRY mode and on MED speed in AUTO mode.

Note: There is no green indicator light for "Auto" mode. When you select "Auto" mode, a beep will sound indicating this "MODE" option was selected.

^ Temperature settings up:

Press the ^ keypad to increase the set (operating) temperature of the unit.

Each time the keypad is pressed the temperature increases by 1°C with a maximum setting of 30°C

∨ Temperature settings down:

Press the ∨ keypad to decrease the set (operating) temperature of the unit.

Each time the keypad is pressed the temperature decreases by 1°C with a minimum temperature of 16°C.

Fan:

Press this keypad button to activate the appropriate fan speed setting. Each press of the button will alternate through LOW, MED, HIGH fan speed options. The green indicator light beside the FAN speed option will illuminate, identifying the fan speed selected.

Swing:

Press the "SWING" keypad to activate the automatic air swing (oscillation) feature.

The green indicator light adjacent to the "SWING" keypad will illuminate, identifying that the selected mode is operational. The vertical louvers will oscillate back and forth (side to side) automatically sweeping air around for comfortable cooling/heating. To stop the air swing feature, pressing the "SWING" keypad again, the green indicator light adjacent to the keypad will go off.

When the SLEEP mode is activated, the green indicator light beside the "SLEEP" function will illuminate.

Timer:

Press the "TIMER" keypad to activate the "auto start/auto stop" timer function.

Auto start/stop programs can be set from 1/2-24 hours.

Dry:

In the Dry mode, the air conditioner will operate in the form of a dehumidifier.

Note: Since the conditioned space is a closed or sealed area, some degree of cooling will continue.

Cooling:

The temperature settings are adjustable between 16°C to 30°C. Cooling begins automatically when the room temperature is 1°C above the set point, and stops when the room temperature is 1°C below the set point. The fan will not stop running.

Heat:

The temperature settings are adjustable between 16°C to 30°C in heating mode.

The default temperature setting is 24°C in heating mode and the fan speed is optional.

Note: To help heat the room evenly. Keep fan speeds between medium & high.

When heating stops, there may be a slight delay of 30 seconds for the fan motor to stop.

Auto:

For the cooling only models, after selecting "AUTO" by pressing the "MODE" button, the air conditioner will select the appropriate operating mode from "FAN", "COOL" or "DRY" based upon the temperature difference between the actual and desired room temperature.

For the cooling and heating models, after selecting "AUTO" by pressing the "MODE" button, the air conditioner will select the appropriate mode for cool, heat or dry based upon the temperature difference between the actual and desired room temperature. The default heating temperature set point is 20°C, the default cooling temperature set point is 25°C

Note: When activating the SLEEP mode when the unit is in AUTO mode, the fan motor will change into LOW speed mode immediately.

Operating instructions

Sleep:

Press and hold the "SWING" keypad for 2 seconds or use the remote control to activate the "SLEEP" feature. In the Cooling mode, the cooling temperature set point will increase 1°C per hour after the "SLEEP" mode is selected.

Two hours later, the set point will continue at this temperature and the fan motor will remain on LOW speed. In the Heating mode, the heating temperature set point will decrease 1°C per hour after the "SLEEP" mode is selected. Two hours later, the set point will continue at this temperature and the fan motor will remain on LOW speed.

Using the "SLEEP" mode will reduce noise creating a comfortable sleeping environment.

Note: When activating the SLEEP mode in AUTO mode, the set temperature will not change over time.

The hand held remote control unit allows you to control all operational aspects of your Air Conditioner, from the convenience of your favourite armchair. Here are some things you should know about to operate your Air Conditioner with the hand held remote control.

Temperature:

^ Increases / v Decreases operating TEMPERATURE only.

Power ON/OFF:

Turns the power to the main unit "on/off" only.

Mode:

Activates the "AUTO" (if applicable), "HEAT" (if applicable), "COOL", "FAN" or "DRY" function.

Timer:

Activates the "auto START" or "auto STOP" program from 0.5-24 hours (0.5 hour increments).

Sleep:

Activates the "SLEEP" mode.

Swing:

Activates the automatic air SWING (vertical) louver oscillation) feature.

Fan:

Activates the FAN speed settings (HIGH, MED, LOW, AUTO).

Batteries:

To operate the hand held remote control, you will require two AAA 1.5Volt batteries (included).

NOTE: Batteries should be replaced when:

a) No signal (beep) is heard from the main unit when initiating program commands from the remote control to the main unit.

b) The main unit does not respond to the remote control program commands.

Battery Replacement:

- 1 Slide the lower (battery) cover down (Located on rear of remote control unit).
- 2 Insert two "AAA" Batteries inside the battery chamber (as depicted inside the battery chamber).
- 3 Re-install lower battery cover.
- 4 If the remote control is not being used for extended time periods, (vacation, off season) the batteries should be removed from the remote control unit.

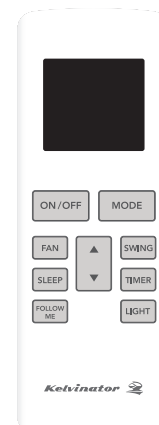

Operating instructions

Remote Control Operating Instructions:

The hand held remote control unit operates within a range of 7 metres (23ft) from the receiver located inside the unit. Any obstruction between the receiver and the hand held remote may cause signal interference, limiting the ability to program the main unit.

Each time a remote control button is pressed, a beep will sound indicating a command (signal) is transmitted and received on the unit. When the command is received, the appropriate function will be displayed (temporarily) in the LED display window and the green indicator light corresponding to the selection mode will illuminate on the main control panel.

Note: The LED display will default to show the ambient room temperature within 10 seconds of all program commands.

Power:

To turn the (air conditioner) power on/off, aim the remote control at the receiver (window) on the unit and press the "POWER" button.

Mode:

Press the "MODE" button to select either "AUTO", "HEATING", "COOLING", "FAN" or "DRY" mode (Cooling & Heating model) or "COOLING", "FAN" or "DRY" mode (Cooling only model).

Set cooling/heating/auto temperature:

Press the "TEMP" (up/down) buttons to select (increase/decrease) the required operating temperature, the selected temperature will appear (temporarily) in the LED display.

The temperature settings are adjustable between 16°C and 31°C.

Fan:

Press the "FAN" button to select the required operating fan speed (HIGH, MED or LOW).

Swing:

Press the "SWING" button to activate the swing feature (the vertical louvres will oscillate automatically from side to side). Press the "SWING" button again to deactivate the "SWING" feature.

Timer:

Press the "TIMER" button to activate the "auto start/auto stop" timer function. Under ON status, press the button to set timer OFF; Under OFF status, press the button to set timer ON. Time setting range is 0.5~24hours.

Auto:

Press the "AUTO" button to activate the "AUTO" function and the unit will be running according to room temperature.

Light:

Press this button to turn the control panel display On & Off.

Note: The display will be On as a default setting.

Sleep:

Press the "SLEEP" button to activate the "SLEEP" feature.

Press the "SLEEP" button to deactivate the "SLEEP" feature. In Cooling mode, the cooling temperature set point will increase 1°C per hour after the "SLEEP" mode is selected. After two hours, the set temperature will remain constant. In Heating mode, the heating temperature set point will decrease 1°C per hour after the sleep button is pressed and then remain constant.

Follow Me:

Push this button to initiate the "FOLLOW ME" feature, which allows the indoor ambient temperature reading to be taken from the remote control. The remote control will send this signal to the air conditioner every 10 minutes interval until press the "FOLLOW ME" button again. The air-conditioner will cancel the "FOLLOW ME" feature automatically if the indoor unit does not receive the signal from the remote control within a 10 minutes period.

To change Celsius to Fahrenheit

With the air conditioner switched off, press the "MODE" and "▼" buttons simultaneously to switch °C and °F.



caution

NEVER operate the air conditioner without the air filter, as dust/dirt particles can contribute to equipment failure.

Vertical air flow adjustment (manually)

To adjust the vertical air flow direction, adjust any one of the horizontal louvre blades. When adjusting the horizontal louver blades up or down, always keep the top or bottom blades horizontal. This can effectively prevent water droplets condensing on the front panel of the unit.

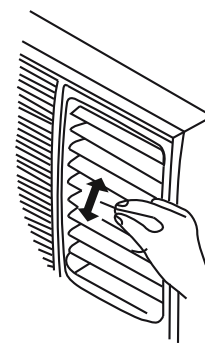

Maintenance

Air Filter

The air filter behind the inlet grille should be checked and cleaned at least once every 2 weeks (or as necessary) to maintain optimal performance of the air conditioner.

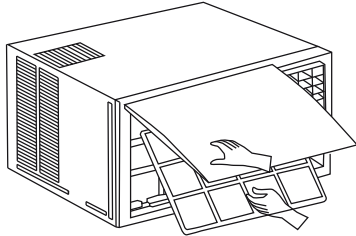

Removing the air filter

- 1 The grille can be opened from the bottom for easy maintenance after installation.
- 2 Open the inlet grille by pulling on the openings in the bottom of the grille
- 3 Pull the tab slightly to release the filter. Pull the filter forward to remove it.
- 4 Clean the filter with warm soapy water. The water should be below 40°C to prevent damage.
- 5 Rinse off and gently shake off any excess water from the filter. Allow the filter to dry before replacing it. To prevent damage, do not dry in direct sunlight.

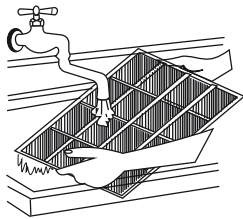

AUTO restart

During a power failure, the air conditioner will stop completely. When the power is restored, the air conditioner will start automatically with all the previous settings preserved in the memory.

The treatment of condensed water

- 1 Take out the drain pan and screws (provided within your air conditioner accessories bag).
- 2 Install the drain pan at the bottom of the unit and secure it with the screws provided.
- 3 Connect a suitable sized drain hose (not supplied) to the drain outlet located on the underside of the drain pan.
- 4 Ensure the rear of the air conditioner (outside) lower than the front of the air conditioner (inside) to allow water to drain (see following page for detail)

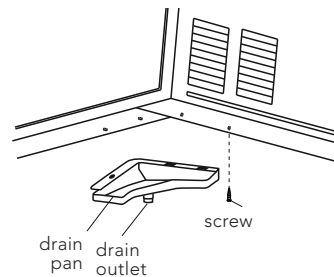

Drain plug (Cooling only models)

- 1 The drain plug is fitted from the factory to capture condensed water to maximise the cooling efficiency of this product.
- 2 There may be some sound of splashing water under some conditions.
- 3 This configuration is used for testing the capacity and efficiency of this product for performance rating purposes.
- 4 The drain plug can be removed to drain water to a specific location and/or reduce noise but drain plug removal can reduce performance.

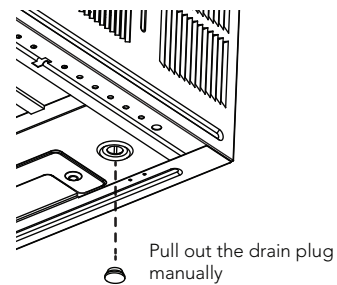

Installation instructions

Select the best location

- To avoid vibration and noise, make sure the unit is installed securely and firmly.
- Install the unit where the sunlight does not shine directly on the unit.
If the unit receives direct sunlight, build an awning to shade the cabinet.
- There should be no obstacle, such as a fence or wall, within 50cm from the back of the cabinet because it will prevent heat radiation of the condenser.
Restriction of outside air will greatly reduce the cooling and heating efficiency of the air conditioner.
- Install the unit with rear angled down so as not to leak condensed water into the room (about 3°~4° angle with level).
- Install the unit with its bottom portion 75~150cm above the floor level.
- The power cord must be connected to an independent circuit. The yellow/green wire must be grounded.
- Based on calculations in compliance with AS60335.2.40 there is no minimum safe floor area for the installation of the air conditioners described in this manual.

caution

All side louvers of the cabinet must remain exposed to the outside of the structure.

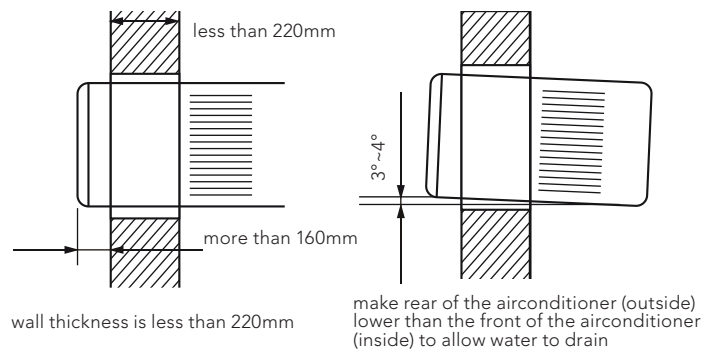

Installation of the Housing

- Remove the air conditioner from its packaging, remove fixing screws and slide the air conditioner out of its housing (Refer to Installation Steps).
- Prepare the hole in the wall so that the bottom of the housing is well supported, the top has minimum clearance and the air inlet louvers have clearance as shown below in options A and B. Holes from the outside through to the cavity should be sealed. The housing should slope down towards the rear by about 3°~4° to allow water formed during operation to drain.
- Install the housing into the wall and secure. Ensure the foam seals are not damaged. Flash, seal or fill gaps around the inside and outside to provide satisfactory appearance and protection against the weather, insects and rodents.

Note: Unit may be supported by a solid frame from below or by a hanger from a solid overhead support.

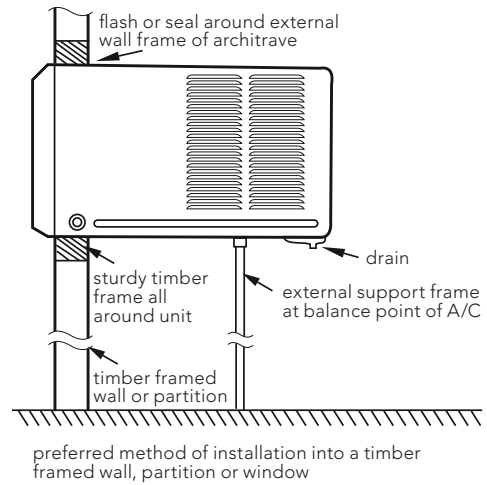

Installation of the unit into the housing

- Slide the unit into the housing until it is firmly against the rear of the housing. Care is required to ensure the foam sealing strips on the housing remain in position.
- Connect the air conditioner to the power and position excess cord length beneath the air conditioner base.
- Engage the chassis fixing brackets into the bottom housing rail and secure to the base with the screws provided.
- Remove the front panel from its carton and plastic bag and fit as per the Installation Instruction.
- Switch unit on. Check for operation of the unit and check for vibration in the installation.
- Fit the drain pan to the housing and run a drain line to a suitable location if required.

Installing the unit into the wall

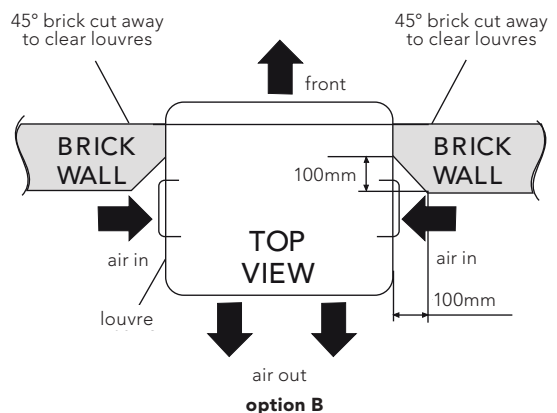
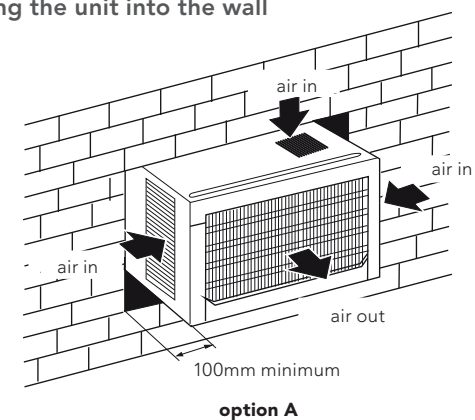

Installation instructions

Installation Steps

Step 1. Remove the front panel and the air filter

- 1 Hold the slot under the front panel, then lift it up and outwards, and remove the front panel (See Fig.1).
- 2 Pinch the handle under the air filter, bend the filter gently and remove it from the slots (See Fig.2).

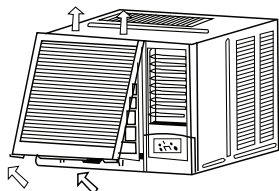

Fig. 1

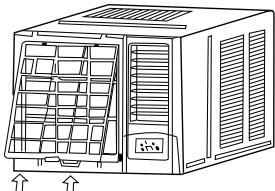

Fig. 2

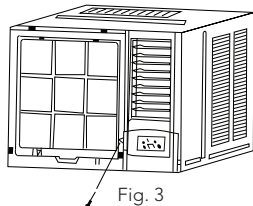

Fig. 3

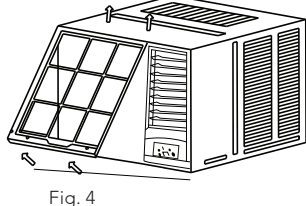

Fig. 4

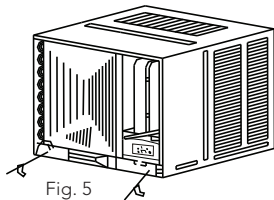

Fig. 5

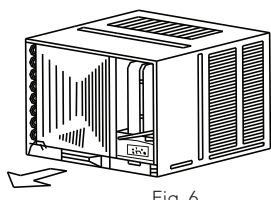

Fig. 6

Step 2. Remove the frame.

- 1 Remove fixing screws from the frame (See Fig.3). Screws can be in different positions of the frame for different models, usually there are 2 screws at the rear of the larger units and one screw at the mid front right. Smaller units have less screws.
- 2 Release the front panel lugs on the side of the front panel from the outer frame slots at top, middle and bottom where they meet. Grasp the left corner of the frame's underside, then loosen the frame (See Fig.4).

Step 3. Installation.

- 1 Remove the fixing screw on the chassis fixing bracket, then remove the chassis fixing bracket (See Fig.5).
- 2 Grasp the handle on the chassis and carefully slide the air conditioner out of the cabinet (See Fig.6).
- 3 Push the unit chassis into the cabinet (See Fig.7).

- 4 Reinstall the chassis fixing bracket removed earlier (See Fig.5).

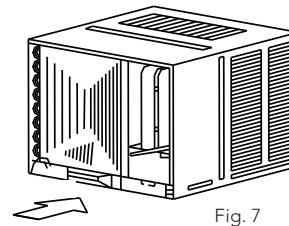

Fig. 7

Install the frame.

- 1 Install the frame making sure not to jam the power supply cable (See Fig.8).

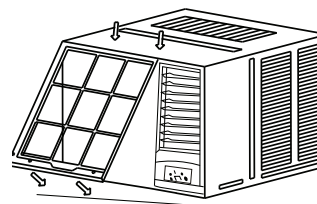

Fig. 8

- 2 Fix the screws on the frame.

Step 5. Install the air filter and front panel.

- 1 Install the air filter into the frame's slot from upside to underside (See Fig.2).
- 2 Hang the front panel on the frame's top edge, then press the front panel into the frame edges until you hear clicks.

Troubleshooting

Troubleshooting Tips

Save time and money! Review the chart below first and you may not need to call for service.

Normal operation

- You may hear a pinging noise caused by water being picked up and thrown against the condenser on rainy days or when the humidity is high. This design feature helps remove moisture and improve efficiency.
- You may hear the thermostat click when the compressor cycles on and off.
- Water will collect in the base pan during high humidity or on rainy days. The water may overflow and drip from the outdoor side of the unit.
- The fan may continue to operate when the compressor has cycled off.

Abnormal operation

Problem	Possible causes	What to do
Air conditioner does not start	The air conditioner is unplugged.	Make sure the air conditioner plug is pushed completely into the outlet and switched on.
	The fuse is blown/circuit breaker is tripped.	Check the house fuse/circuit breaker box and replace the fuse or reset the breaker.
	Power failure.	If power failure occurs, switch off and disconnect/unplug the power cord. When power is restored, reconnect (plug in) the power cord, switch on the power and wait 3 minutes to restart the air conditioner to prevent tripping of the compressor overload.
Air conditioner does not cool as it should	Airflow is restricted.	Make sure there are no curtains, blinds, or furniture blocking the front of the air conditioner.
	The air filter is dirty.	Clean the filter at least every 2 weeks. See the operating instructions section.
	The room may have been hot.	When the air conditioner is first turned on you need to allow time for the room to cool down.
	Cold air is escaping.	Check for open furnace floor registers and cold air returns. Set the air conditioner's vent to the closed position.
	Cooling coils have iced up.	See Air Conditioner Freezing Up below.
Air conditioner freezing up	Ice blocks the air flow and stops the air conditioner from cooling the room.	Set the fan at MED or HIGH until the ice melts.

Electrolux Warranty

FOR SALES IN AUSTRALIA AND NEW ZEALAND
KELVINATOR WINDOW/WALL AIR CONDITIONER

This document sets out the terms and conditions of the product warranties for Kelvinator Appliances. It is an important document. Please keep it with your proof of purchase documents in a safe place for future reference should there be a manufacturing defect in your Appliance. This warranty is in addition to other rights you may have under the Australian Consumer Law.

1. In this warranty:

- (a) 'ACL' or 'Australian Consumer Law' means Schedule 2 to the Competition and Consumer Act 2010;
- (b) 'Appliance' means any Electrolux product purchased by you and accompanied by this document;
- (c) 'ASC' means Electrolux's authorised serviced centres;
- (d) 'Kelvinator' is the brand controlled by Electrolux Home Products Pty Ltd of 163 O'Riordan Street, Mascot NSW 2020, ABN 51 004 762 341 in respect of Appliances purchased in Australia and Electrolux (NZ) Limited (collectively "Electrolux") of 3-5 Niall Burgess Road, Mount Wellington, in respect of Appliances purchased in New Zealand;
- (e) 'Warranty Condition' means:
 - (i) evidence by the customer that the Appliance was installed in accordance with Electrolux installation guidelines as set out in the installation manual;
 - (ii) the Appliance rating is correct for the size and thermal characteristics of the room;
 - (iii) the Appliance has been regularly maintained in accordance with Electrolux guidelines as set out in the user manual;
 - (iv) the Appliance is designed for providing human comfort and should be used under ambient conditions as set out in the product specifications and general air quality conditions.
- (f) 'Warranty Period' means the period specified in clause 3 of this warranty;
- (g) 'you' means the purchaser of the Appliance not having purchased the Appliance for re-sale, and 'your' has a corresponding meaning.

2. Application: This warranty only applies to new Appliances, purchased and used in Australia or New Zealand and is in addition to (and does not exclude, restrict, or modify in any way) other rights and remedies under a law to which the Appliances or services relate, including any non-excludable statutory guarantees in Australia and New Zealand.

3. Warranty Period: Subject to these terms and conditions, this warranty continues for in Australia for a period of 60 months and in New Zealand for a period of 60 months, following the date of original purchase of the Appliance.

4. Repair or replace warranty: During the Warranty Period, Electrolux or its ASC will, at no extra charge if your Appliance is readily accessible for service, without special equipment and subject to these terms and conditions, repair or replace any parts which it considers to be defective. Electrolux may, in its absolute discretion, choose whether the remedy offered for a valid warranty claim is repair or replacement. Electrolux or its ASC may use refurbished parts to repair your Appliance. You agree that any replaced Appliances or parts become the property of Electrolux.

5. Travel and transportation costs: Subject to clause 7, Electrolux will bear the reasonable cost of transportation, travel and delivery of the Appliance to and from Electrolux or its ASC. Travel and transportation will be arranged by Electrolux as part of any valid warranty claim.

6. Proof of purchase is required before you can make a claim under this warranty.

7. Exclusions: You may not make a claim under this warranty unless the defect claimed is due to faulty or defective parts or workmanship. This warranty does not cover:

- (a) light globes, batteries, filters or similar perishable parts;
- (b) parts and Appliances not supplied by Electrolux;
- (c) cosmetic damage which does not affect the operation of the Appliance;
- (d) damage to the Appliance caused by:
 - (i) negligence or accident;
 - (ii) misuse or abuse, including failure to properly maintain or service;
 - (iii) improper, negligent or faulty servicing or repair works done by anyone other than an Electrolux authorised repairer or ASC;
 - (iv) normal wear and tear;
 - (v) power surges, electrical storm damage or incorrect power supply;
 - (vi) incomplete or improper installation;
 - (vii) incorrect, improper or inappropriate operation;
 - (viii) insect or vermin infestation;
 - (ix) failure to comply with any additional instructions supplied with the Appliance; and
 - (x) a breach of the Warranty Conditions.

In addition, Electrolux is not liable under this warranty if:

- (a) the Appliance has been, or Electrolux reasonably believes that the Appliance has been, used for purposes other than those for which the Appliance was intended, including where the Appliance has been used for any non-domestic purpose;
- (b) the Appliance is modified without authority from Electrolux in writing;
- (c) the Appliance's serial number or warranty seal has been removed or defaced.

8. How to claim under this warranty: To enquire about claiming under this warranty, please follow these steps:

- (a) carefully check the operating instructions, user manual and the terms of this warranty;
- (b) have the model and serial number of the Appliance available;
- (c) have the proof of purchase (e.g. an invoice) available;
- (d) telephone the numbers shown below.

9. Australia: For Appliances and services provided by Electrolux in Australia: Electrolux goods come with guarantees that cannot be excluded under the Australian Consumer Law. You are entitled to a replacement or refund for a major failure and for compensation for any other reasonably foreseeable loss or damage. You are also entitled to have the Appliance repaired or replaced if the Appliance fails to be of acceptable quality and the failure does not amount to a major failure. 'Acceptable quality' and 'major failure' have the same meaning as referred to in the ACL.

10. New Zealand: For Appliances and services provided by Electrolux in New Zealand, the Appliances come with a guarantee by Electrolux pursuant to the provisions of the Consumer Guarantees Act, the Sale of Goods Act and the Fair Trading Act. Where the Appliance was purchased in New Zealand for commercial purposes the Consumer Guarantee Act does not apply.

11. Confidentiality: You accept that if you make a warranty claim, Electrolux and its agents including ASC may exchange information in relation to you to enable Electrolux to meet its obligations under this warranty.

Important Notice

Before calling for service, please ensure that the steps listed in clause 8 above have been followed.

AUSTRALIA	FOR SERVICE or to find the address of your nearest authorised service centre in Australia PLEASE CALL 13 13 49 <small>For the cost of a local call</small>	FOR SPARE PARTS or to find the address of your nearest spare parts centre in Australia PLEASE CALL 13 13 50 <small>For the cost of a local call</small>
NEW ZEALAND	FOR SERVICE or to find the address of your nearest authorised service centre in New Zealand PLEASE CALL 0800 10 66 10	FOR SPARE PARTS or to find the address of your nearest spare parts centre in New Zealand PLEASE CALL 0800 10 66 20



If you'd like further information about Kelvinator appliances, please visit your retailer, phone or email our Customer Care team or visit our website.

telephone: 13 13 49

email: customercare@electrolux.com.au

web: kelvinator.com.au

Kelvinator. We are part of the Electrolux family.
Share more of our thinking at www.electrolux.com.au